

Product Description

The QPF4001 is a multi-function Gallium Nitride MMIC front - end module targeted for 28 GHz phased array 5G base stations and terminals. Fabricated on Qorvo's 0.15um GaN on SiC process, the device combines a low noise high linearity LNA, a low insertion-loss high - isolation TR switch, and a high - gain high - efficiency multi-stage PA.

The QPF4001 operates from 26 GHz to 30 GHz. The receive path (LNA + TR SW) is designed to provide 17 dB of gain and a typical noise figure of 3.5dB. The transmit path (PA + SW) provides 27 dB of small signal gain with high linearity of 35 dBc ACPR and low EVM of 3% at 23 dBm average output power, while supporting peak power of 1 - Watt.

The compact 5 x 4 mm air-cavity laminate surface mount package with embedded copper heat slug employs a low thermal resistance die attached process, this makes QPF4001 ideal for phased array applications with tight lattice spacing and extreme temperature requirements.

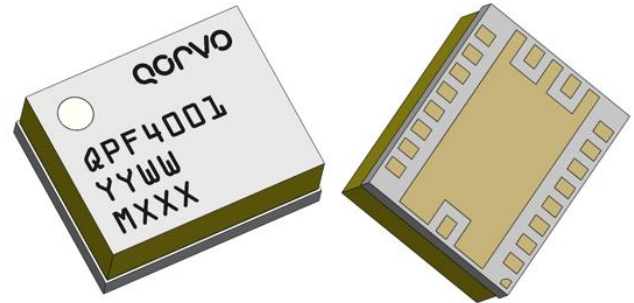

Product Features

- Frequency Range: 26 – 30 GHz ¹
- RX Noise Figure: 3.5 dB
- RX Small Signal Gain: 17 dB
- RX Saturated Power: 17 dBm
- RX TOI: 21 dBm @ - 4 dBm Pin / tone
- TX Small Signal Gain: 27 dB
- TX Saturated Power (CW): 31 dBm
- TX TOI: 39 dBm @ -6 dBm Pin / tone
- TX ACPR: 35dBc @ 23 dBm average Pout
- TX Linearity: 3 % EVM @ 23 dBm average Pout ²
- TX PAE: 8 % @ 23 dBm average Pout ²
- Package Dimensions: 5.0 x 4.0 x 1.8 mm

1. Performance is typical at room temperature
2. OFDM, 400 MHz modulation bandwidth, 256 QAM

Applications

- 5G Wireless Base Stations and Terminals
- Point to Point Communications

Functional Block Diagram

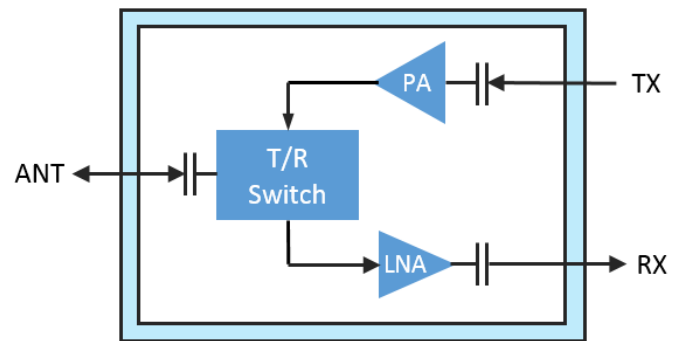

Part No.	Description
QPF4001S2	Sample Bag, Qty 2
QPF4001SR	Tape and Reel, Qty 100
QPF4001EVBV1	QPF4001 Evaluation Board

Normal Operating Conditions

Parameter	Value
Drain Voltage (TXVD12, TXVD3, RXVD) ^{1, 4}	20 V (RXVD should be on during RX - and TX - operation)
Drain Current (TXIDQ12 / TXIDQ3)	68 mA / 20 mA
Drain Current (RXIDQ) ³	15 mA
Gate Voltage (TXVG12 / TXVG3) ²	- 2 V / -2.5 V
Gate Voltage (RXVG) ²	- 2.2 V
Control Voltage (SW) for TX on, RX off ^{3, 4}	SW = 0 V (RXVD = 20 V)
Control Voltage (SW) for TX off, RX on ^{3, 4}	SW = 20 V (should be the same as RXVD if RXVD is not 20 V)
Operating Temperature Range	- 40 to 95 °C

1 Electrical specifications are measured at specified test conditions, no guarantee over all recommended operating conditions.

2 Gate voltages shown are typical, can be adjusted to set required drain current.

3 When in TX mode, the drain of receive channel is turned off by an internal switch.

4 The RXVD should be on during RX- and TX- operation. SW high - level should use the same voltage as RXVD.

Electrical Specifications RX

Test conditions, unless otherwise noted: VD = 20 V, IDQ = 15 mA, SW = 20 V, RXVD = 20 V
Data de-embedded to device reference planes, 25 °C

Parameter	Min	Typical	Max	Units
Frequency	26		30	GHz
Small Signal Gain		17		dB
Noise Figure		3.5		dB
Saturated Output Power		17		dBm
Input Return Loss		11		dB
Output Return Loss		11		dB
Output TOI, @ -4 dBm Pin / tone, 10 MHz tone spacing		21		dBm
Gain Temperature Coefficient		-0.035		dB/°C

Electrical Specifications TX

Test conditions unless otherwise noted: VD = 20 V, TXIDQ12 / TXIDQ3 = 68 mA / 20 mA, SW = 0 V, RXVD = 20 V
Data de-embedded to device reference planes, 25 °C

Parameter	Min	Typical	Max	Units
Frequency	26		30	GHz
Small Signal Gain		27		dB
Saturated Output Power, CW		31		dBm
Input Return Loss		10		dB
Output Return Loss		5		dB
Output TOI, @ -6 dBm Pin / tone, 10 MHz tone spacing		39		dBm
ACPR (23 dBm average power, OFDM, 400 MHz, 256 QAM)		-35		dBc
EVM (23 dBm average power, OFDM, 400 MHz, 256 QAM)		3		%
PAE (23 dBm average power, OFDM, 400 MHz, 256 QAM)		8		%
Gain Temperature Coefficient		-0.064		dB/°C

Performance Plots, Small Signal, Receive Path

Test Conditions unless otherwise stated: RXVD = 20 V, RXIDQ = 15 mA, SW = 20 V, 25 °C

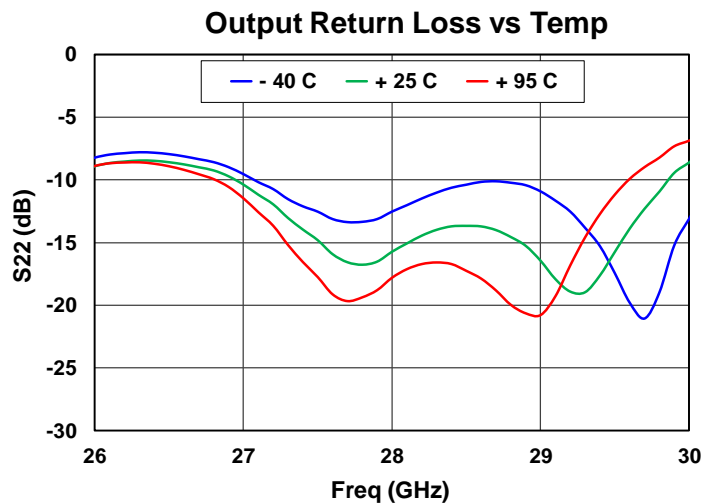
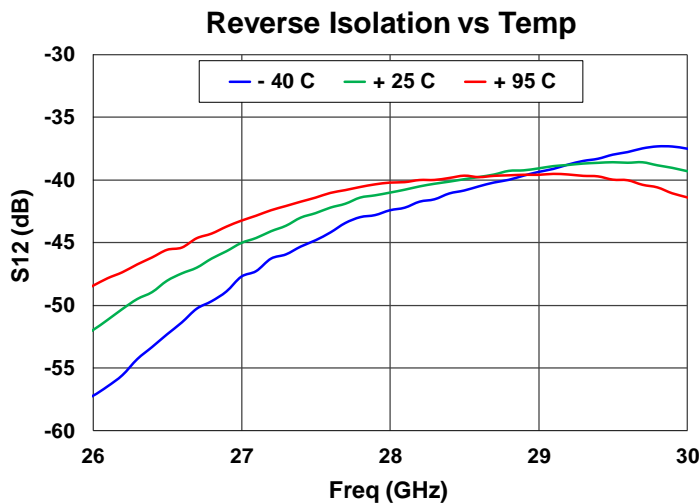
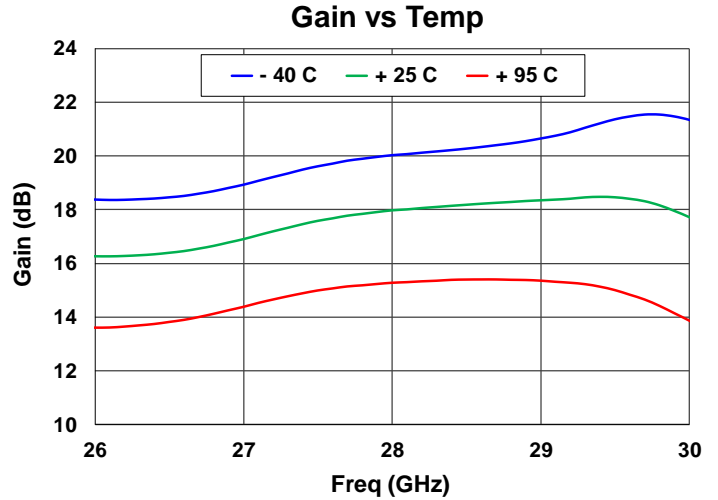
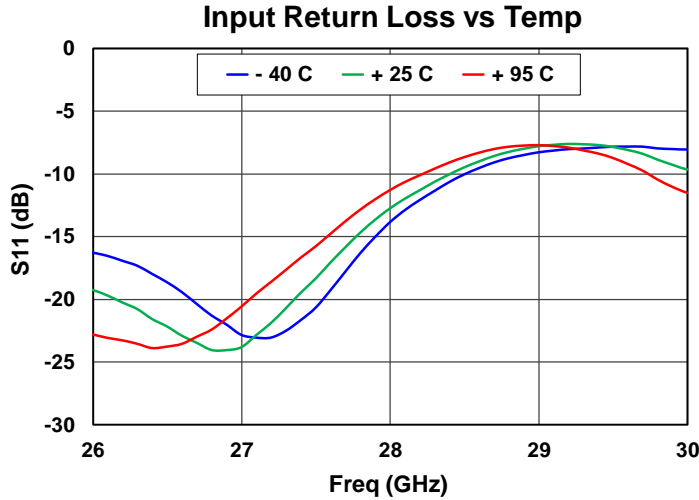

Performance Plots, Small Signal, Receive Path

Test Conditions unless otherwise stated: RXVD = 20 V, RXIDQ = 15 mA, SW = 20 V, 25 °C

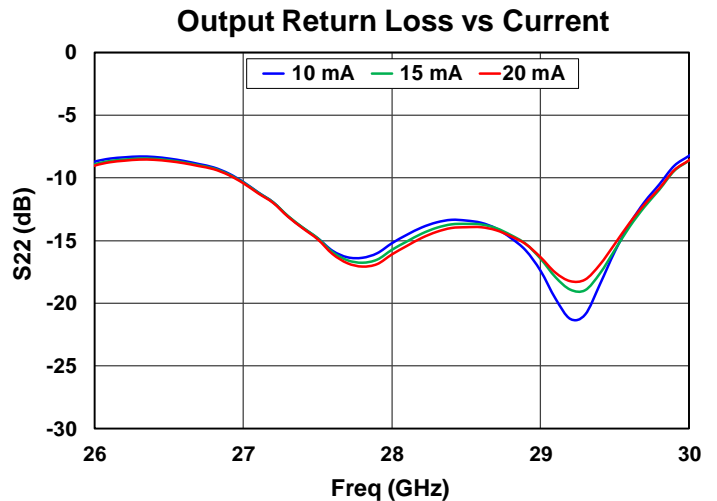
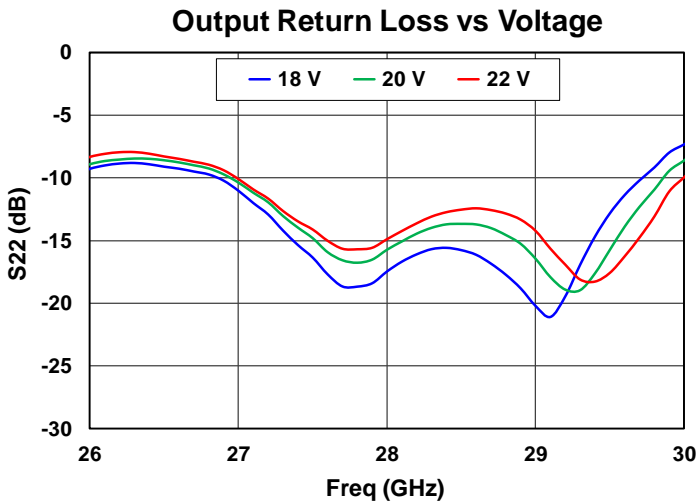
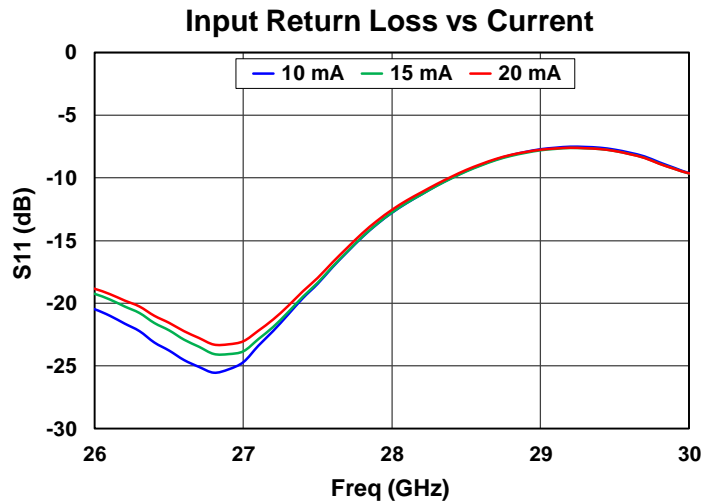
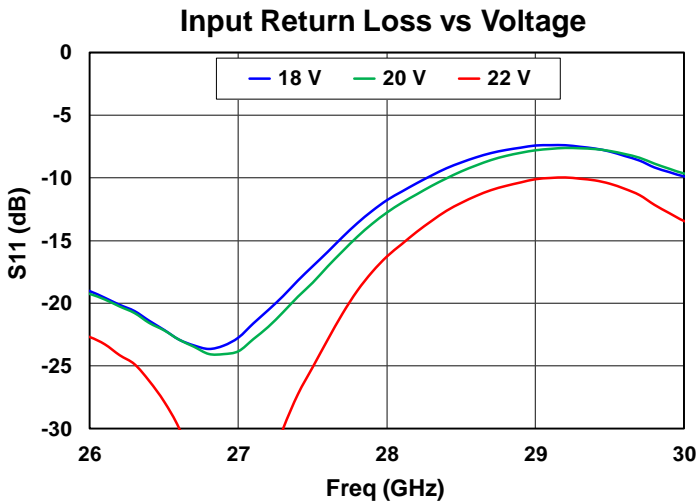
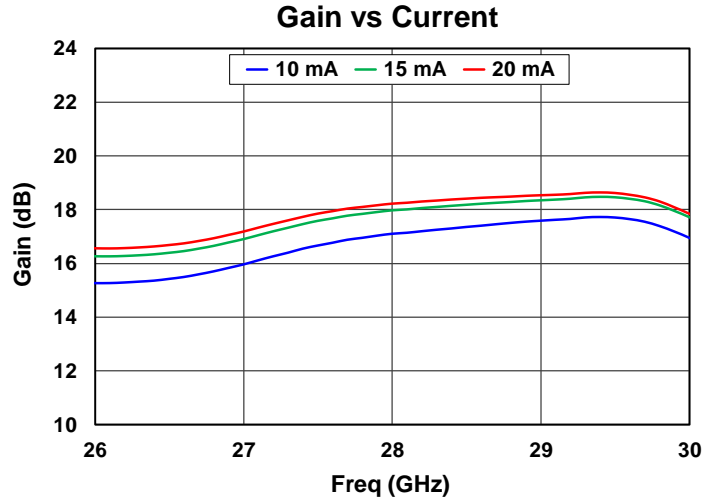
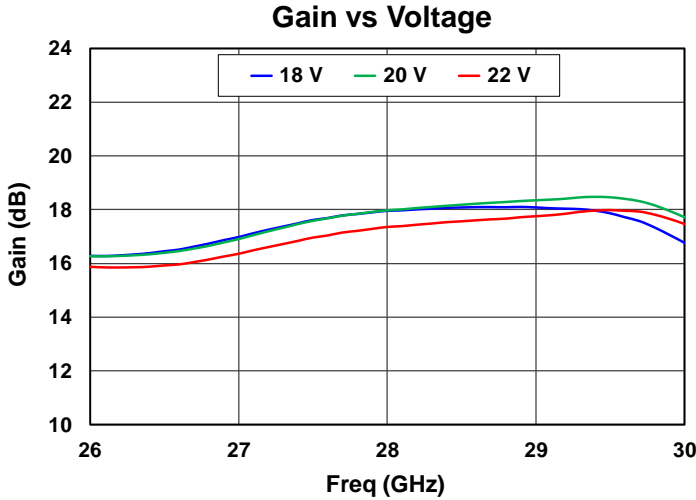

Performance Plots, Noise Figure, Receive Path

Test Conditions unless otherwise stated: RXVD = 20 V, RXIDQ = 15 mA, SW = 20 V, 25 °C

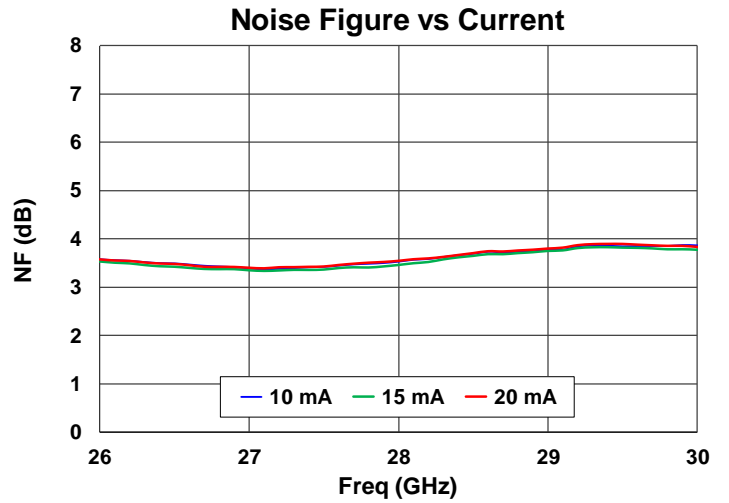
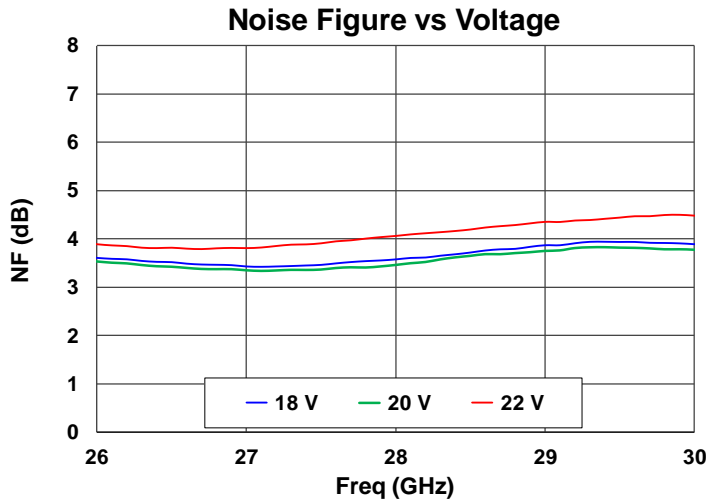
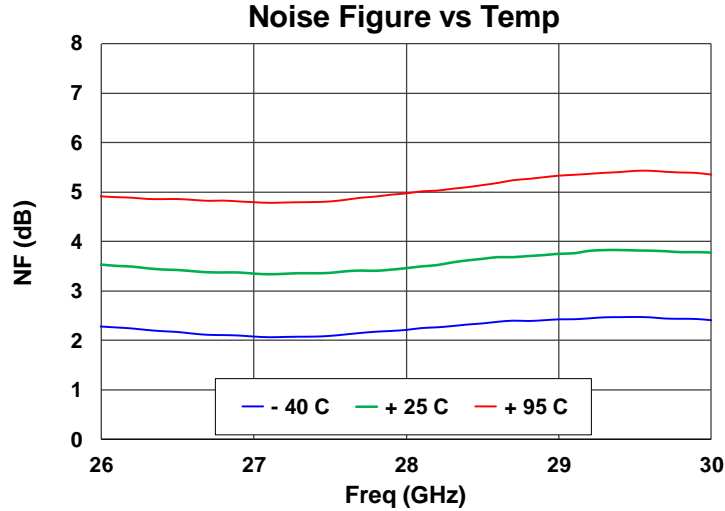

Performance Plots, Large Signal, Receive Path

Test Conditions unless otherwise stated: RXVD = 20 V, RXIDQ = 15 mA, SW = 20 V, CW, 25 °C

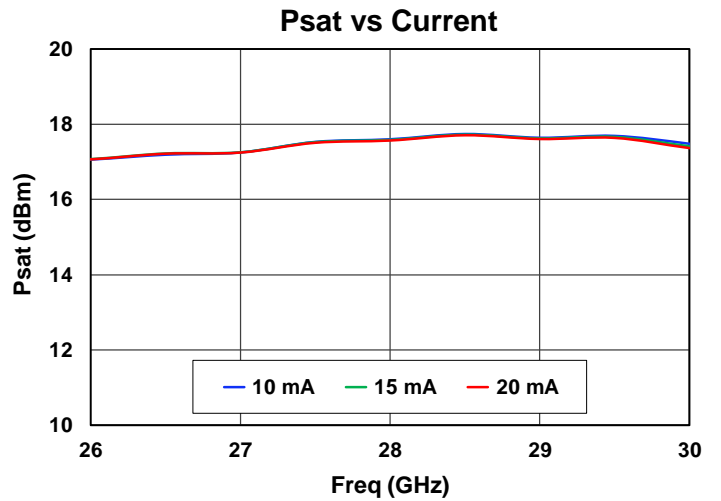
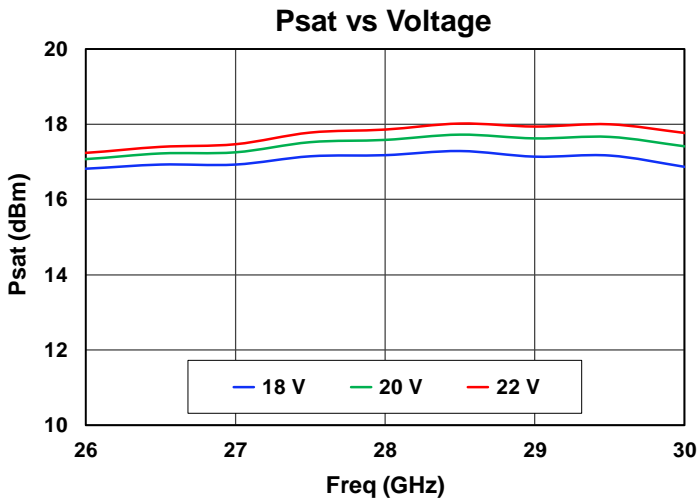
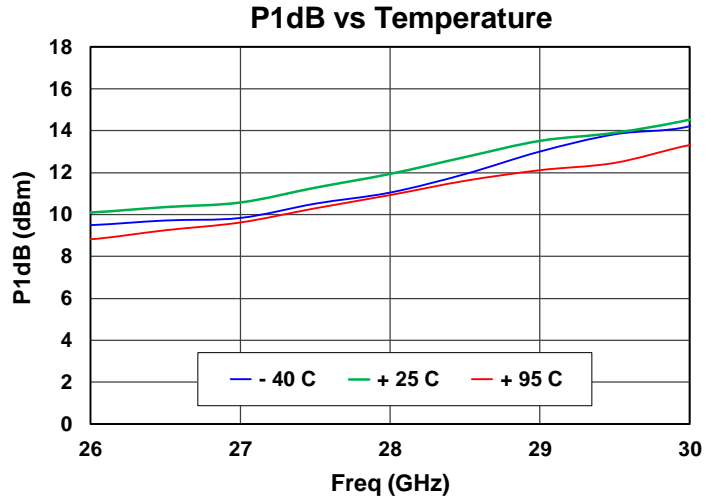
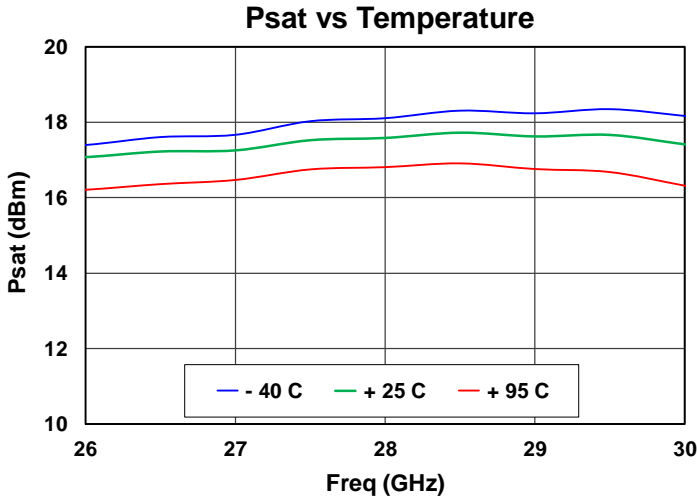

Performance Plots, Large Signal, Receive Path

Test Conditions unless otherwise stated: RXVD = 20 V, RXIDQ = 15 mA, SW = 20 V, CW, 25 °C

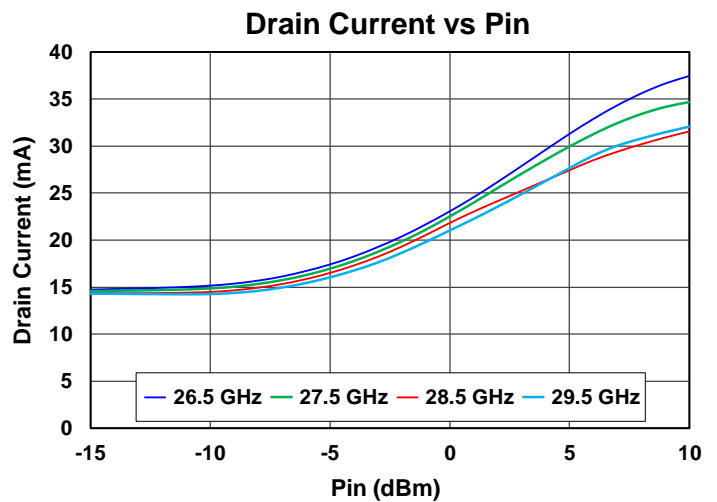
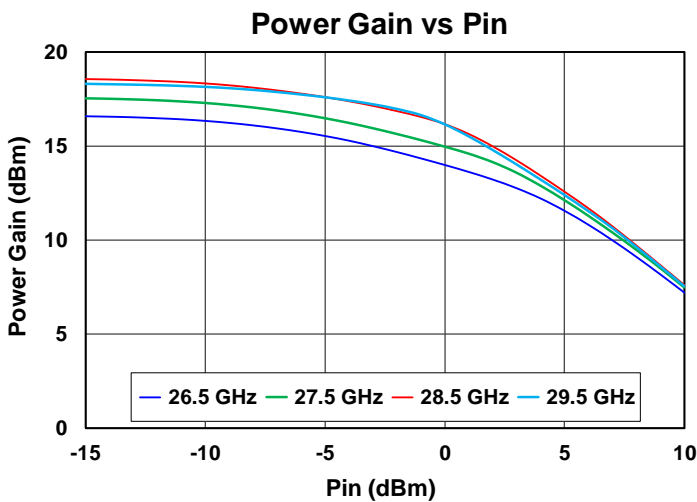
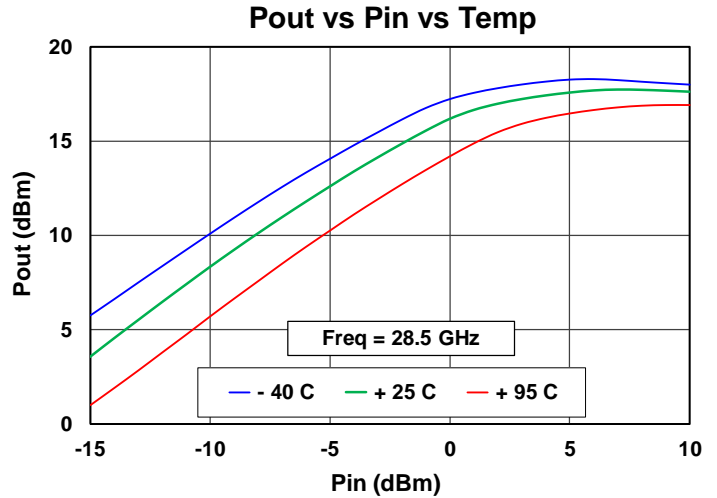
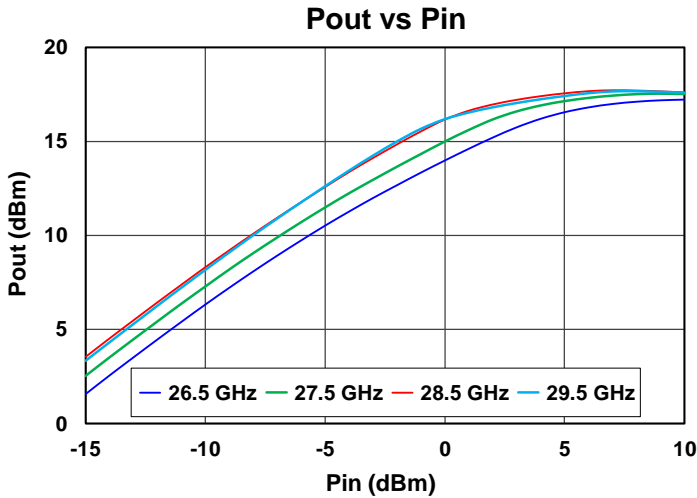

Performance Plots, Linearity, Receive Path

Test Conditions unless otherwise stated: RXVD = 20 V, RXIDQ = 15 mA, SW = 20 V, Tone spacing: 10 MHz, 25 °C

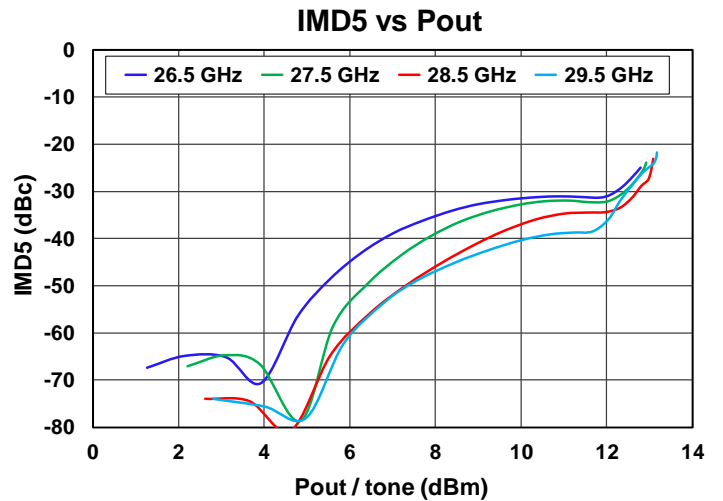
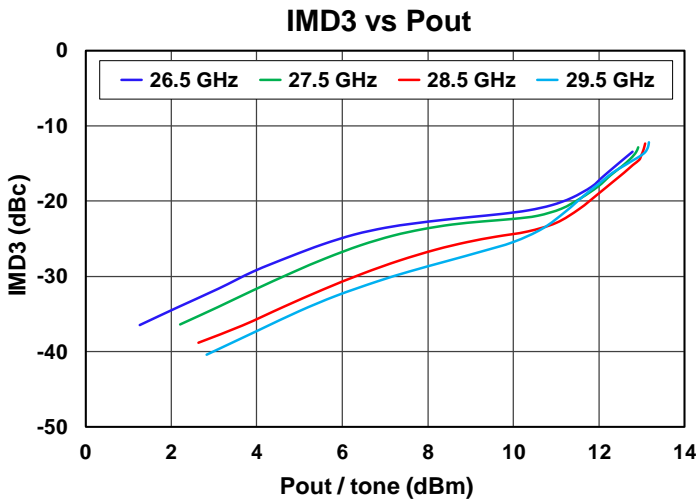
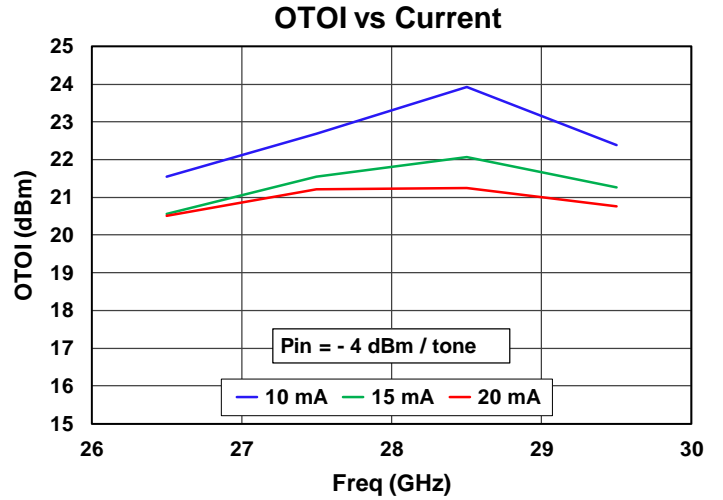
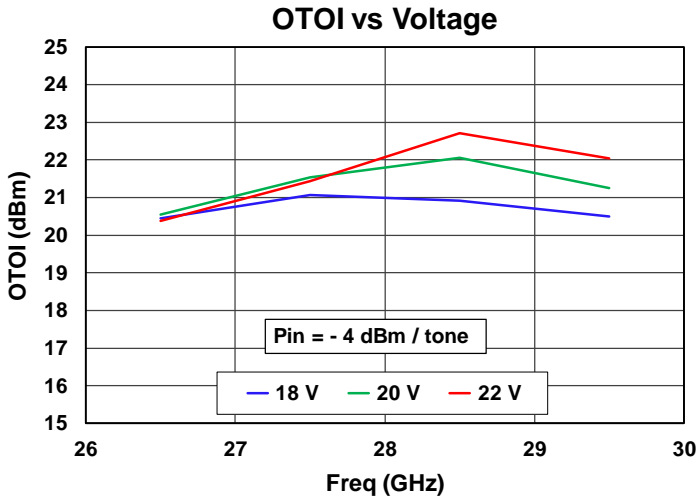

Performance Plots, Small Signal, Transmit Path

Test Conditions unless otherwise stated:

TXVD12 = 20 V, TXVD3 = 20 V, TXIDQ12 = 68 mA, TXIDQ3 = 20 mA, SW = 0 V, RXVD = 20 V, 25 °C

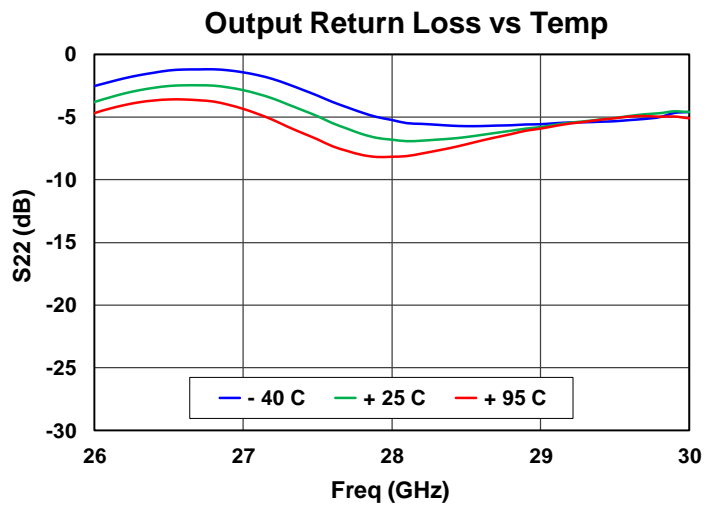
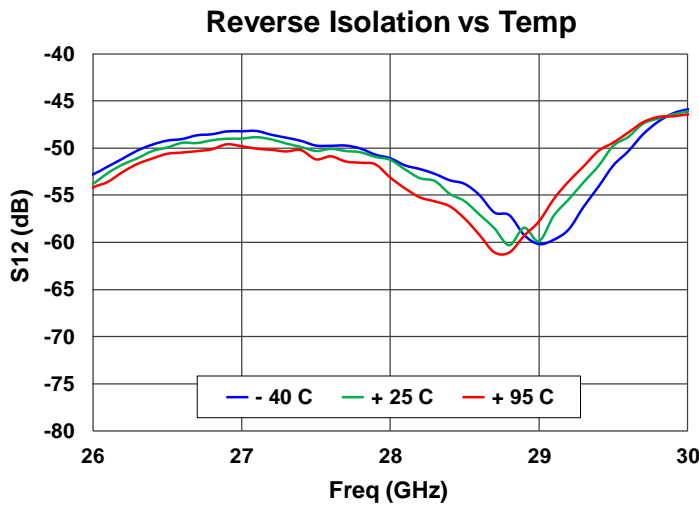
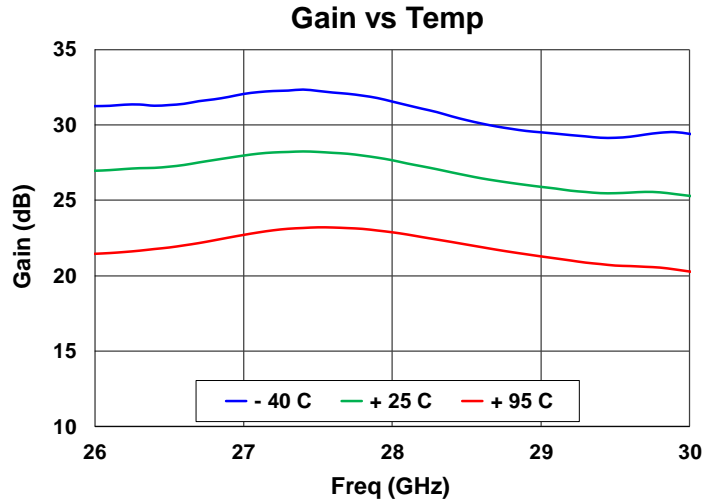
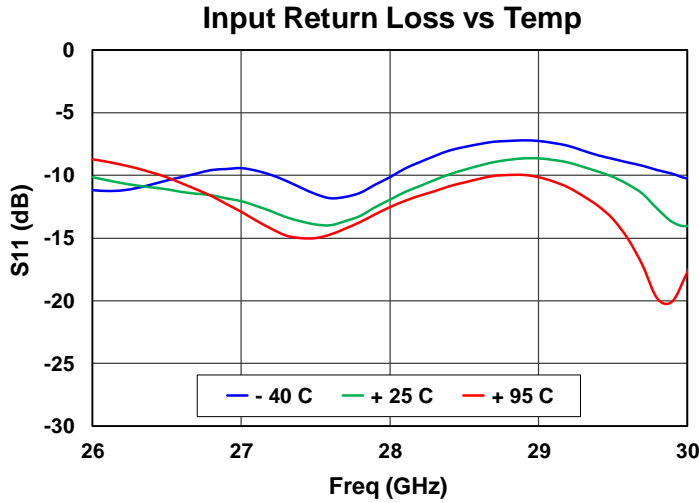

Performance Plots, Small Signal, Transmit Path

Test Conditions unless otherwise stated:

TXVD12 = 20 V, TXVD3 = 20 V, TXIDQ12 = 68 mA, TXIDQ3 = 20 mA, SW = 0 V, RXVD = 20 V, 25 °C

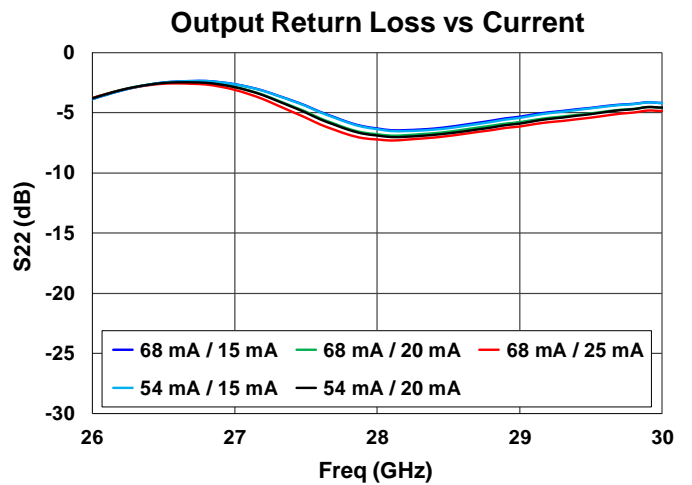
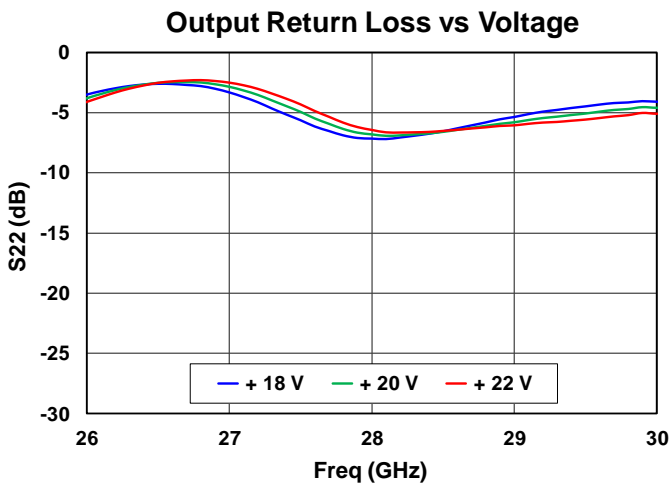
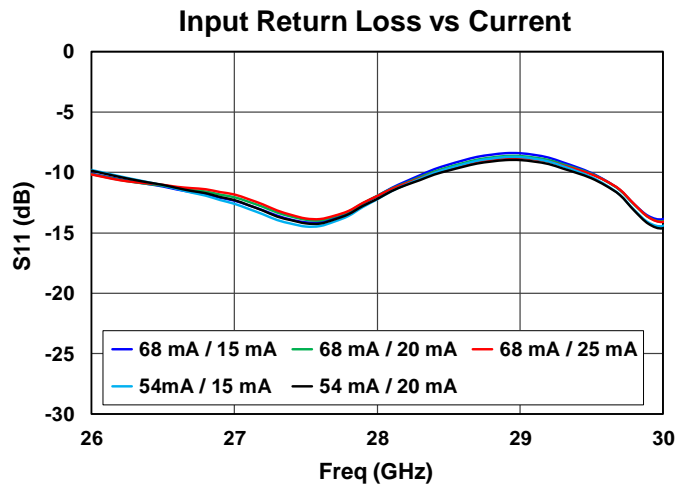
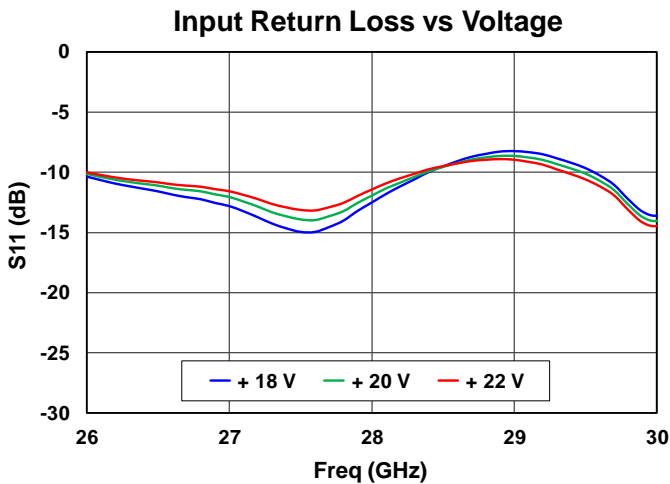
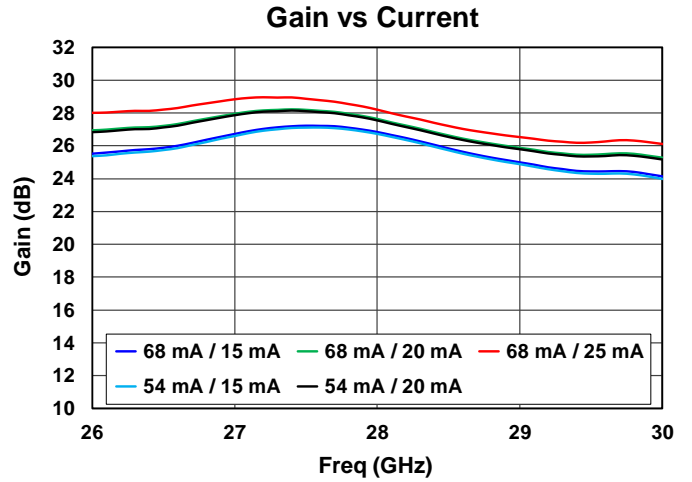
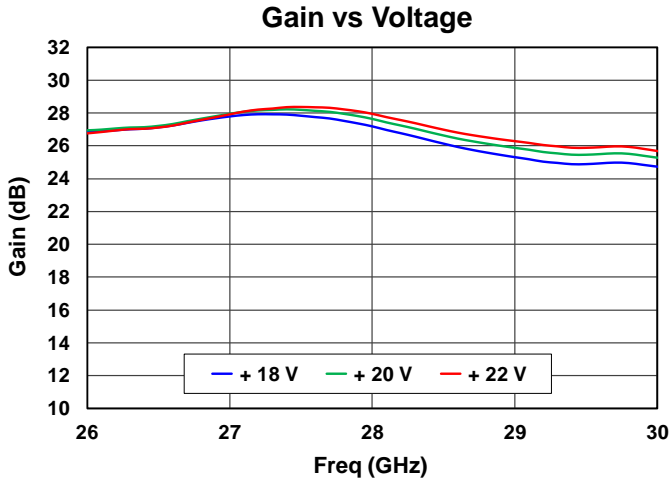

Performance Plots, Large Signal, Transmit Path

Test Conditions unless otherwise stated:

TXVD12 = 20 V, TXVD3 = 20 V, TXIDQ12 = 68 mA, TXIDQ3 = 20 mA, SW = 0 V, RXVD = 20 V, 25 °C

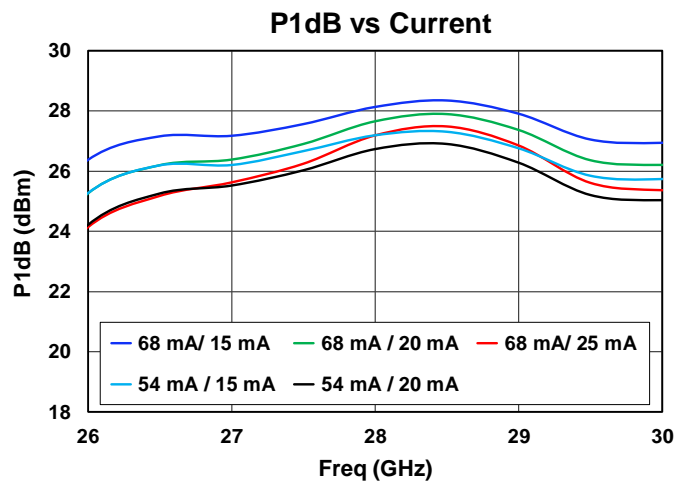
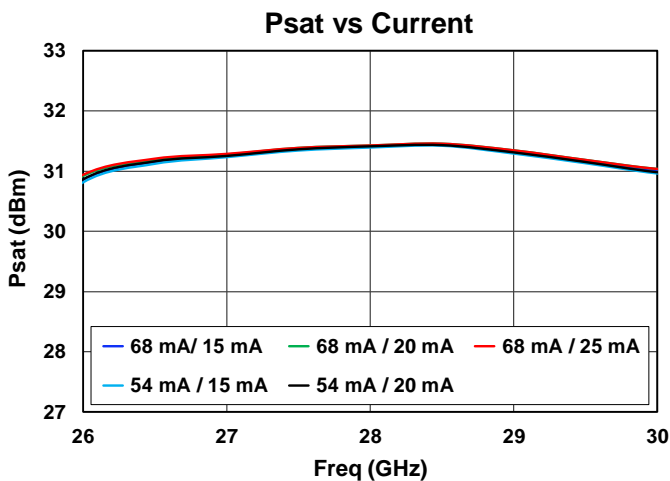
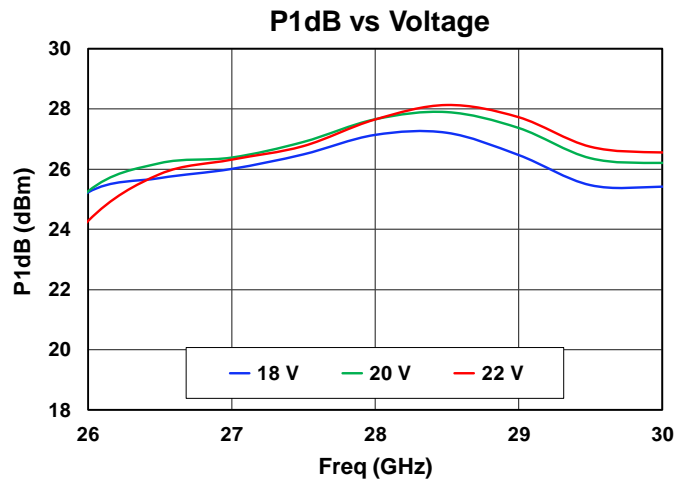
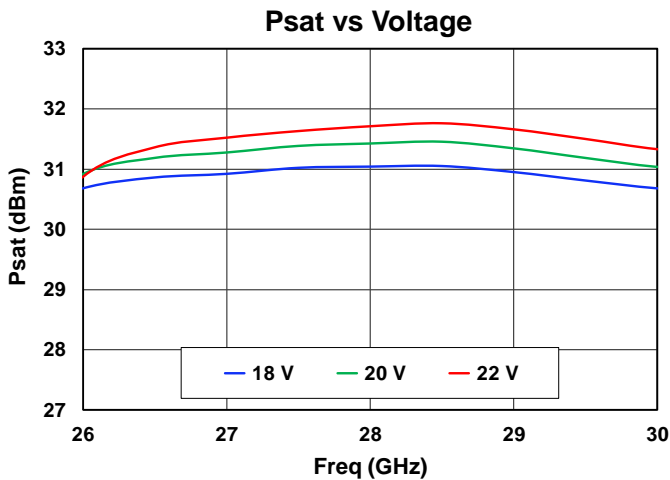
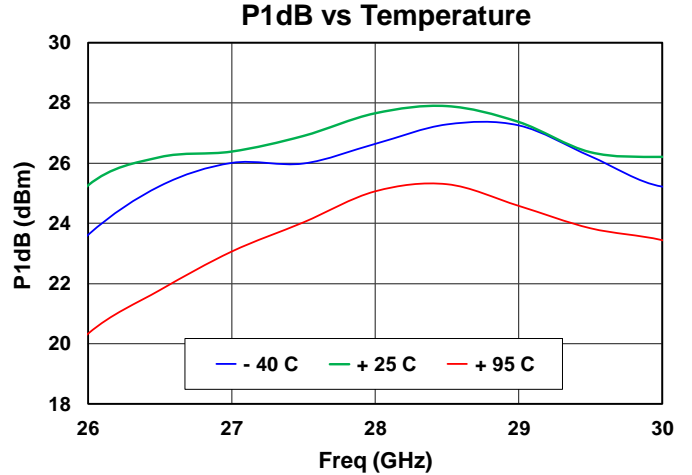
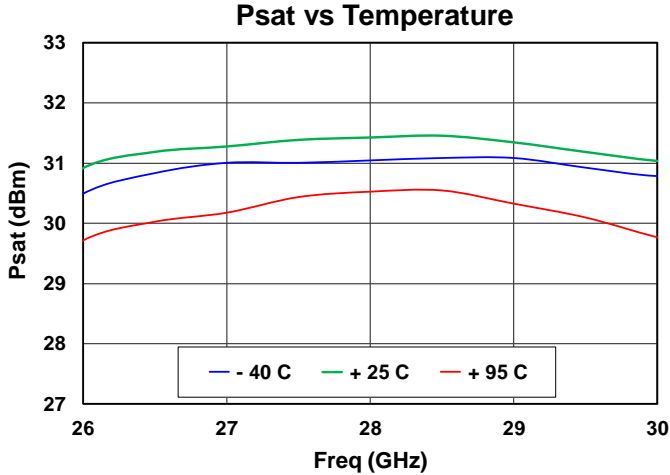

Performance Plots, Large Signal, Transmit Path

Test Conditions unless otherwise stated:

TXVD12 = 20 V, TXVD3 = 20 V, TXIDQ12 = 68 mA, TXIDQ3 = 20 mA, SW = 0 V, RXVD = 20 V, 25 °C

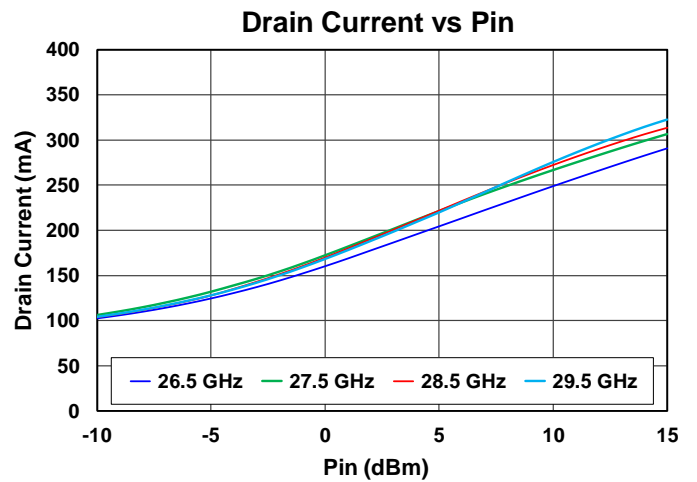
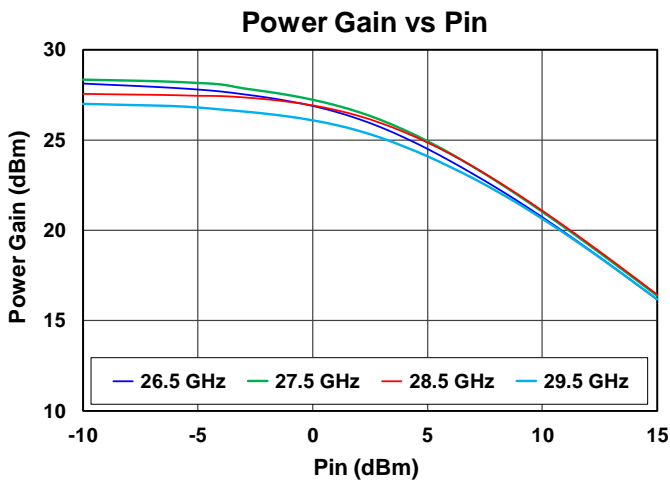
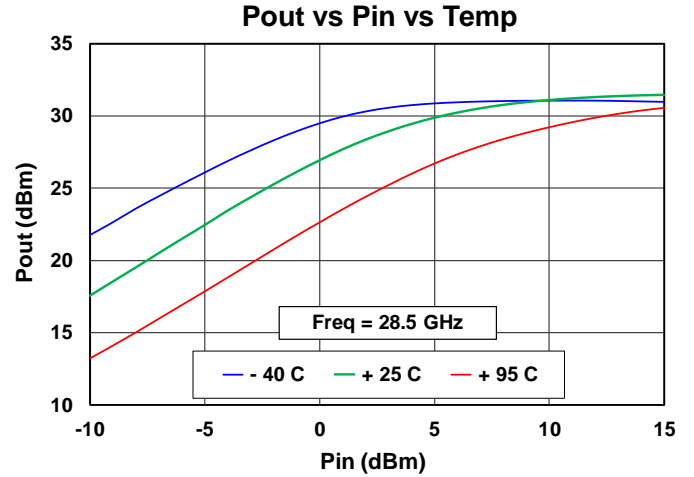
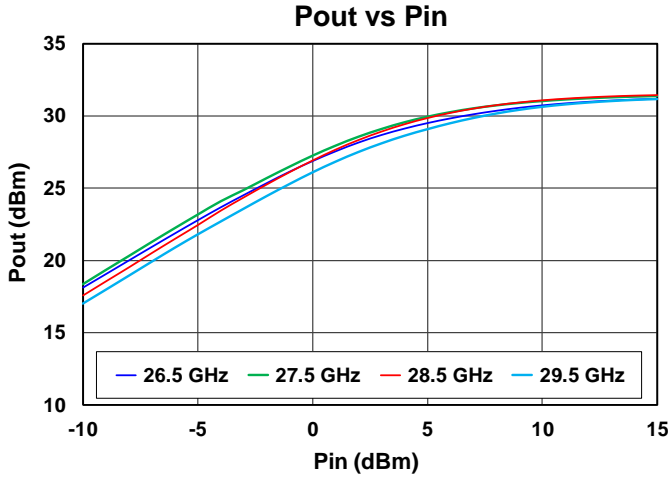

Performance Plots, Linearity, Transmit Path

Test Conditions unless otherwise stated:

TXVD12 = 20 V, TXVD3 = 20 V, TXIDQ12 = 68 mA, TXIDQ3 = 20 mA, SW = 0 V, RXVD = 20 V, Tone Spacing = 10 MHz, 25 °C

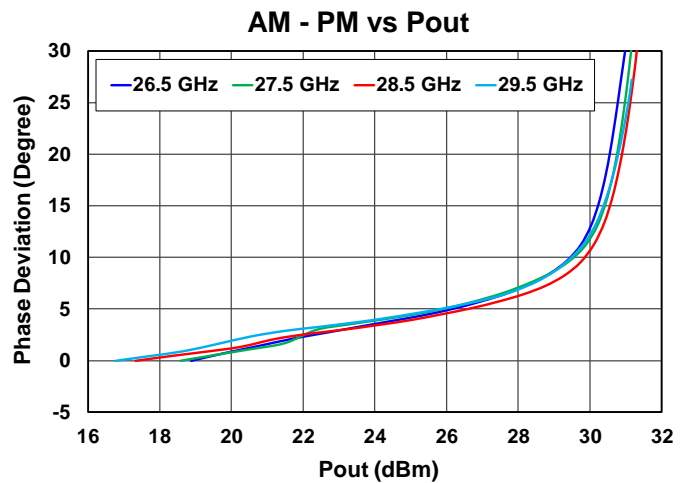
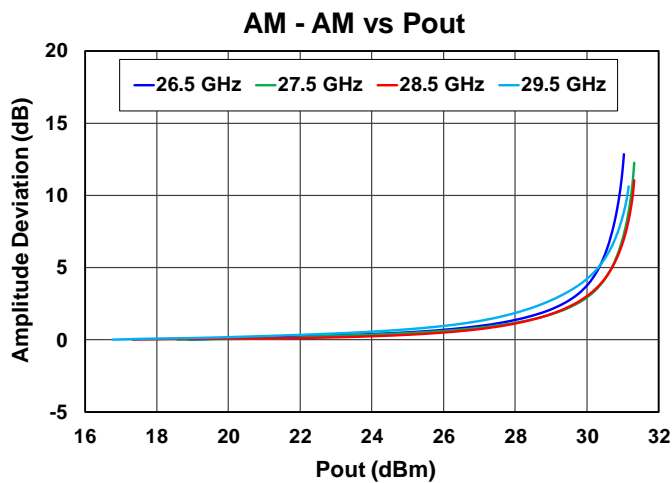
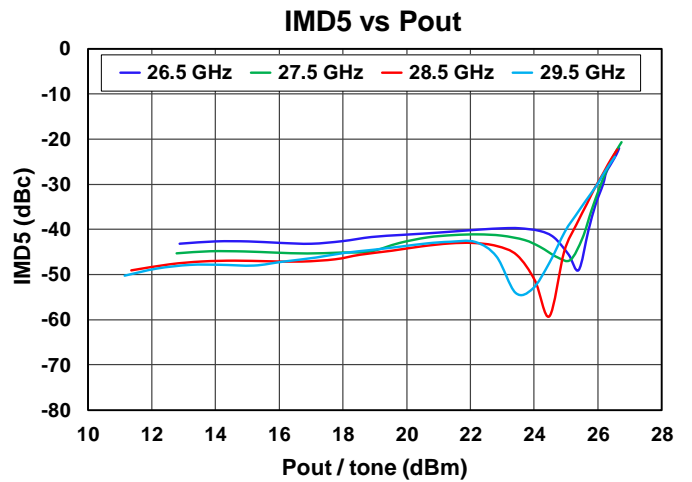
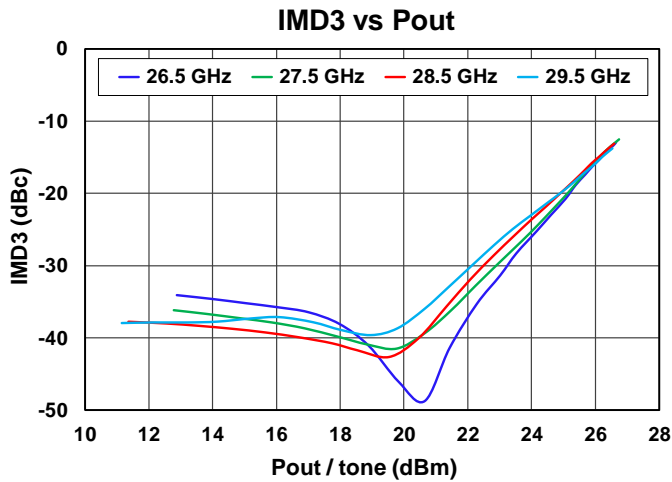
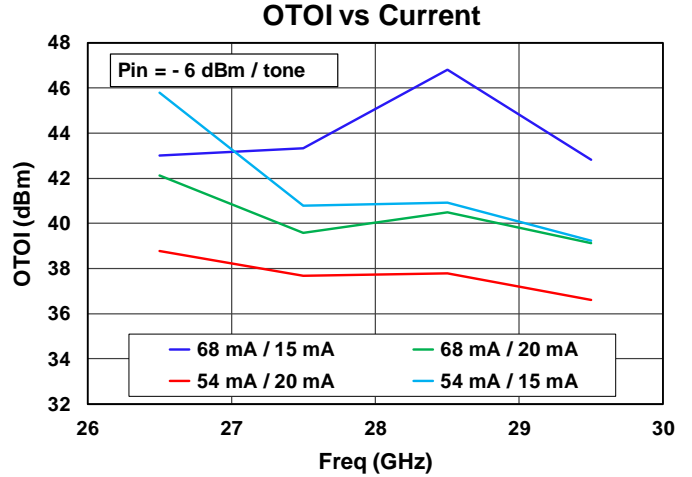
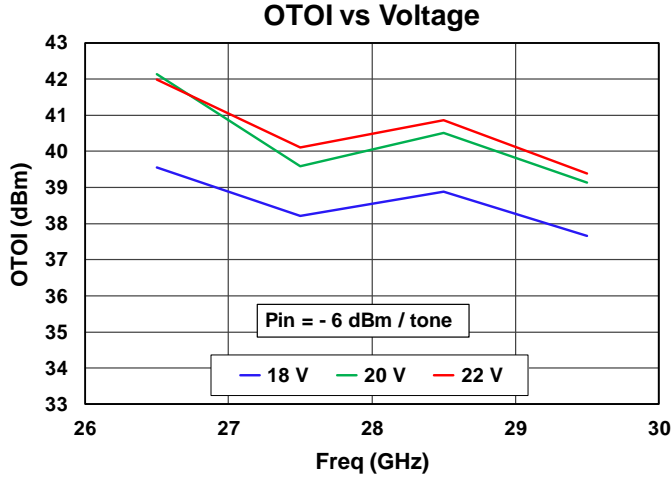

Performance Plots, Modulated Signal, Transmit Path

Test Conditions unless otherwise stated: Source signal: 400 MHz OFDM, 256 QAM
 TXVD12 = 20 V, TXVD3 = 20 V, TXIDQ12 = 68 mA, TXIDQ3 = 20 mA, SW = 0 V, RXVD = 20 V, 25 °C

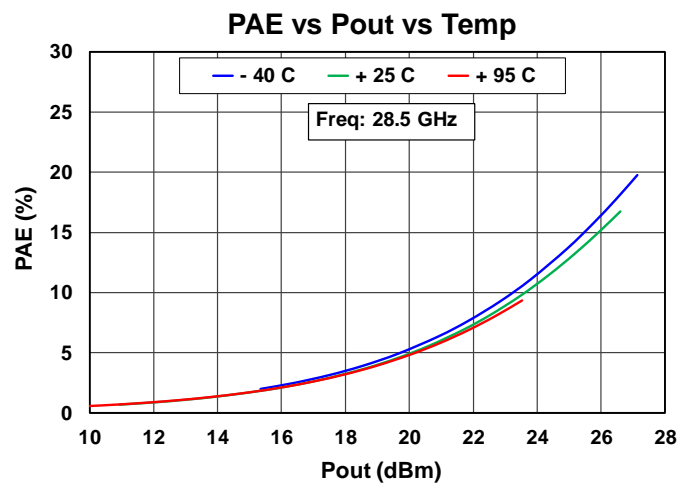
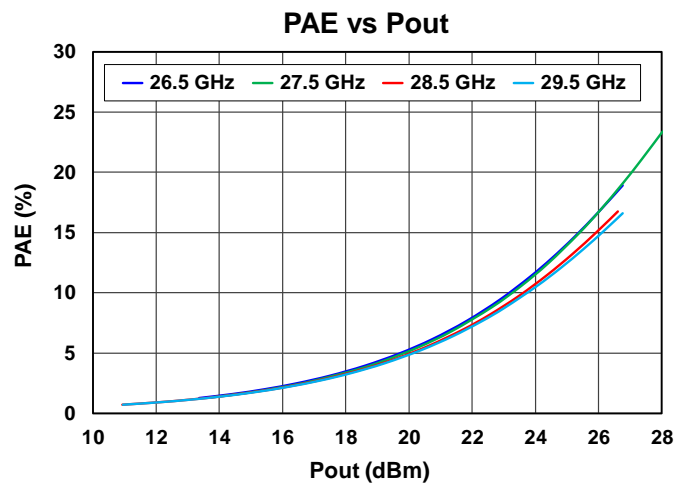
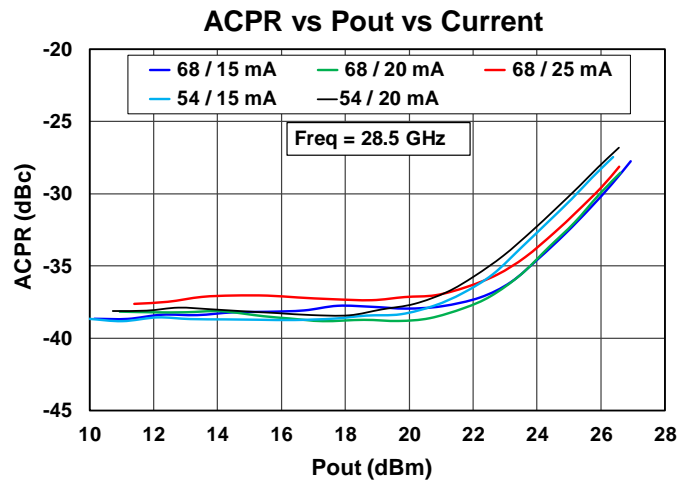
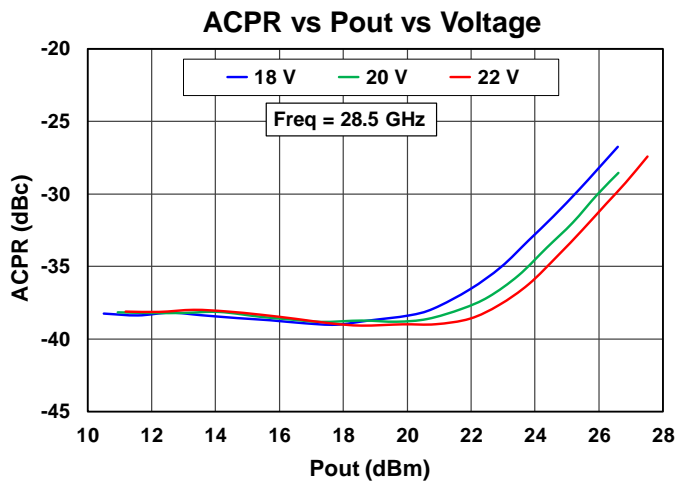
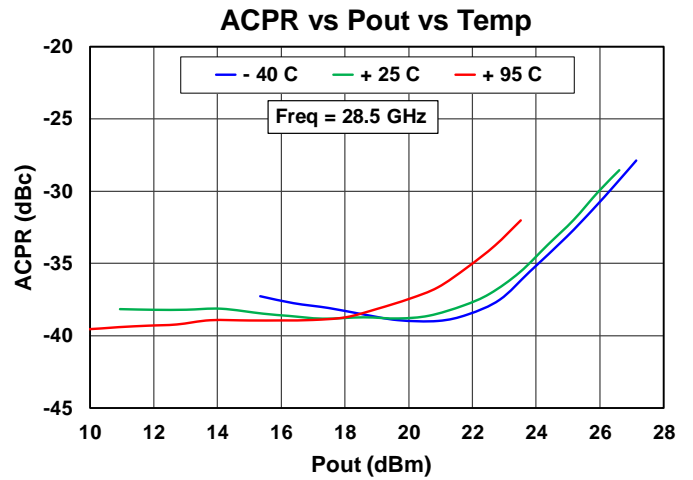
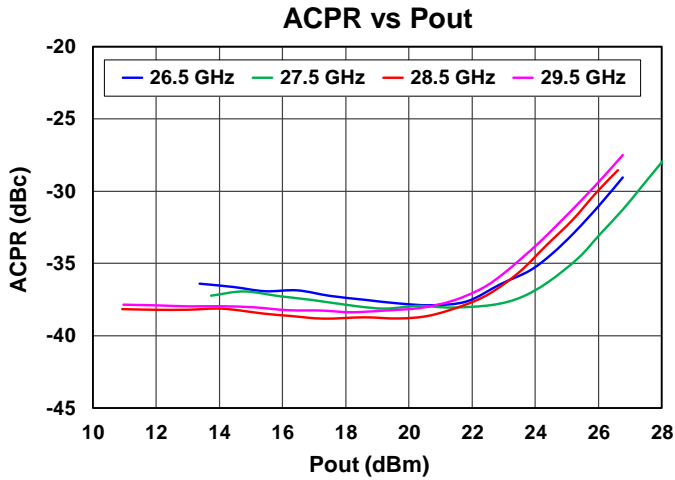

Performance Plots, Modulated Signal, Transmit Path

Test Conditions unless otherwise stated: Signal source: 400 MHz OFDM, 256 QAM
 TXVD12 = 20 V, TXVD3 = 20 V, TXIDQ12 = 68 mA, TXIDQ3 = 20 mA, SW = 0 V, RXVD = 20 V, 25 °C

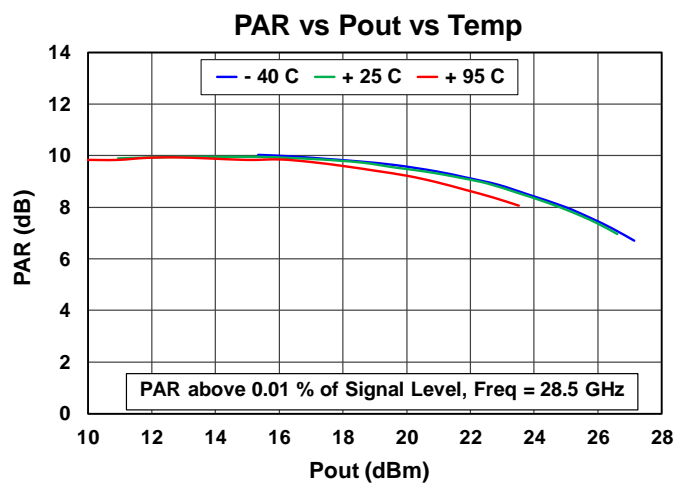
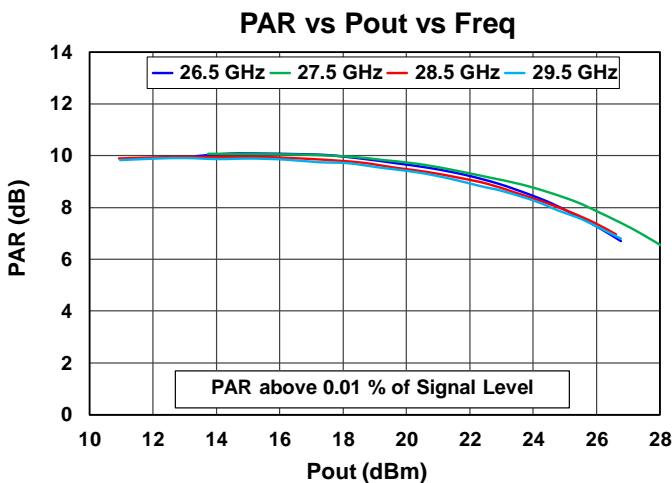
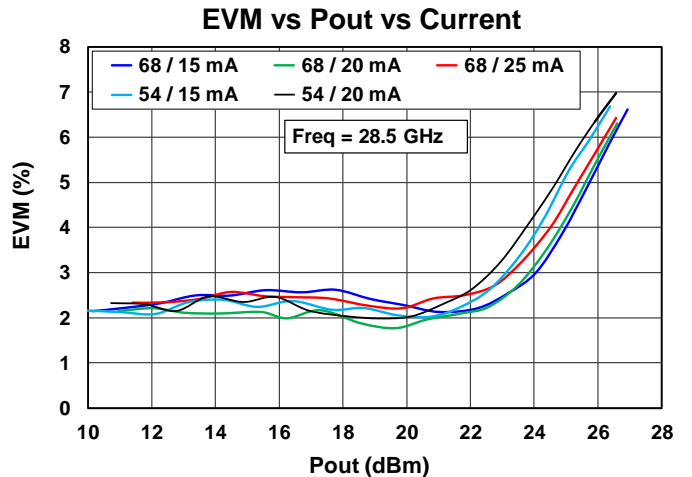
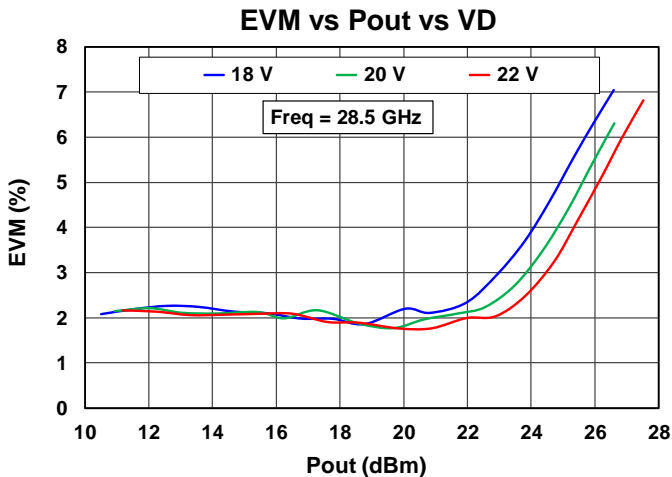
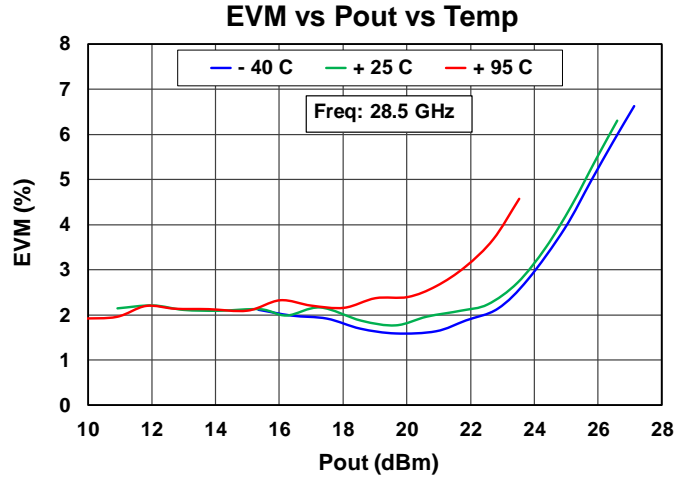
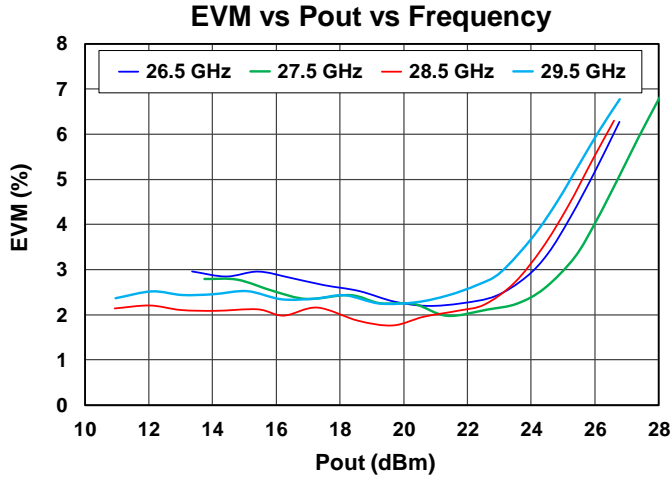

Mechanical Drawings & Pad Descriptions

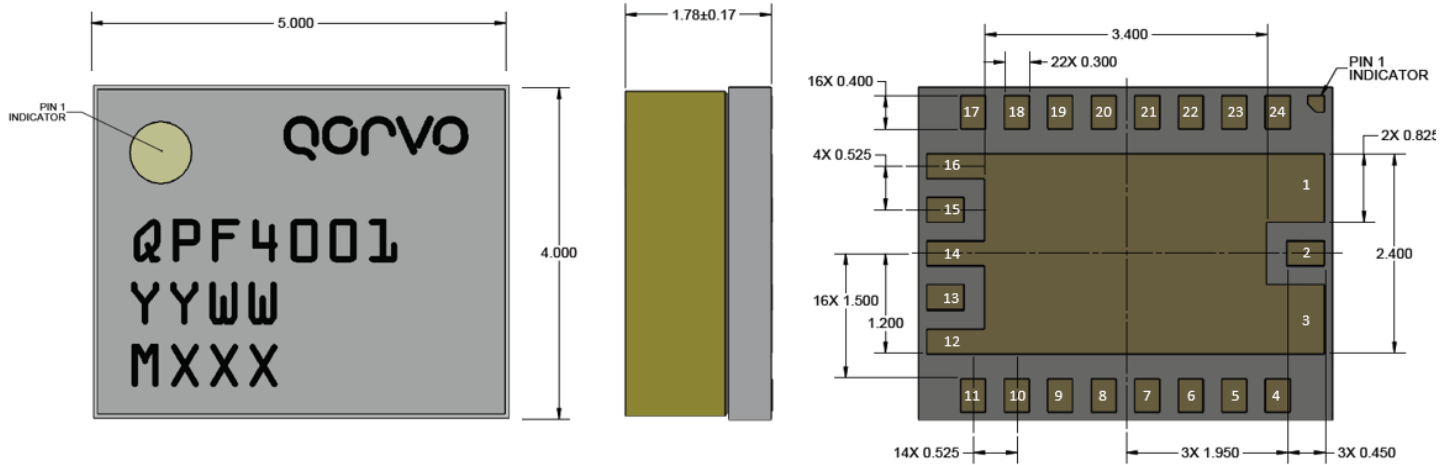

Dimensions in mm. Package lead finish: Ni / Au plating with minimum gold thickness of 0.1 um
 Part Marking: QPF4001: Part Number, YY = Part Assembly Year, WW = Part Assembly Week, MXXX = Batch ID

Pin Number	Label	Description
1, 3, 12, 14, 16, slug	GND	GROUND
2	ANT	Antenna
4	SW	Switch control (internally connected to Pin 24)
10	RXVD	Receive VD
11	RXVG	Receive VG
13	RXOUT	Receive output
15	TXIN	Transmit input
19	TXVG12	Transmit gate control, stages 1 and 2
20	TXVG3	Transmit gate control, stage 3
21	TXVD12	Transmit VD, stages 1 and 2
22	TXVD3	Transmit VD, stage 3
24	SW	Switch control (internal connection to Pin 4)
5, 6, 7, 8, 9, 17, 18, 23	N/C	No internal connection

Evaluation Board and Assembly

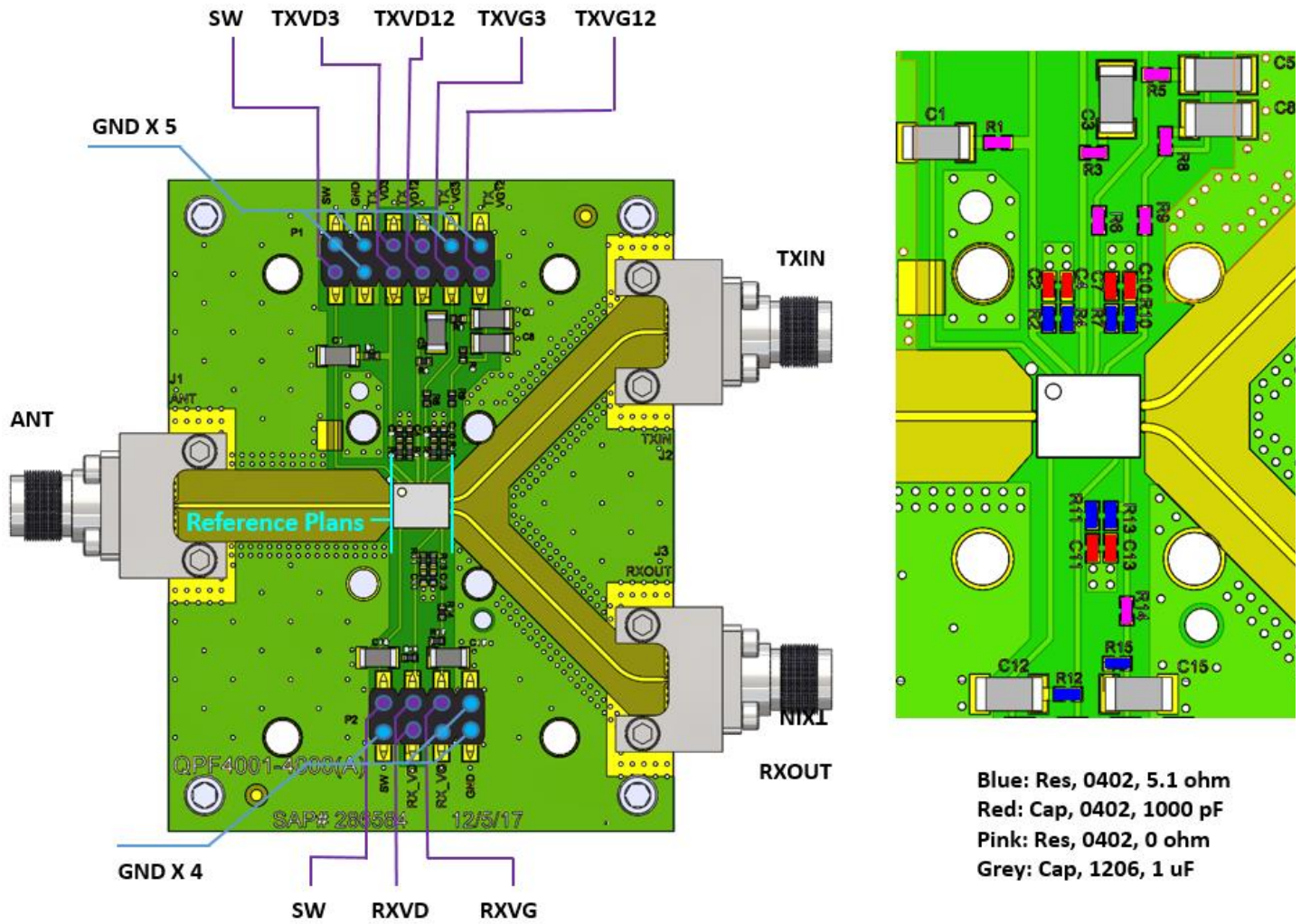

RF Layer is 0.008" thick Rogers Corp. RO4003C ($\epsilon_r = 3.35$). Metal layers are 0.5 oz. copper. The microstrip line at the connector interface is optimized for the Southwest Microwave end launch connector 1092-01A-5.

Ref. Des.	Component	Value	Manuf.	Remark
C2, C4, C7, C10, C11, C13	SMT Cap.	CAP, 0402 1000 pF, 10% 50V 0402 X7R ROHS	Various	Red
C1, C3, C5, C8, C12, C15	SMT Cap.	CAP, 1206 1.0 uF, 10% 50V X7R ROHS	Various	Grey
R2, R4, R7, R10 - R13, R15	SMT Res.	RES, 0402 5.1 ohm, 5% 50V, ROHS	Various	Blue
R1, R3, R5, R6, R8, R9, R14	SMT Res.	RES, 0402 0 ohm, 5%, ROHS	Various	Pink

Application Circuit

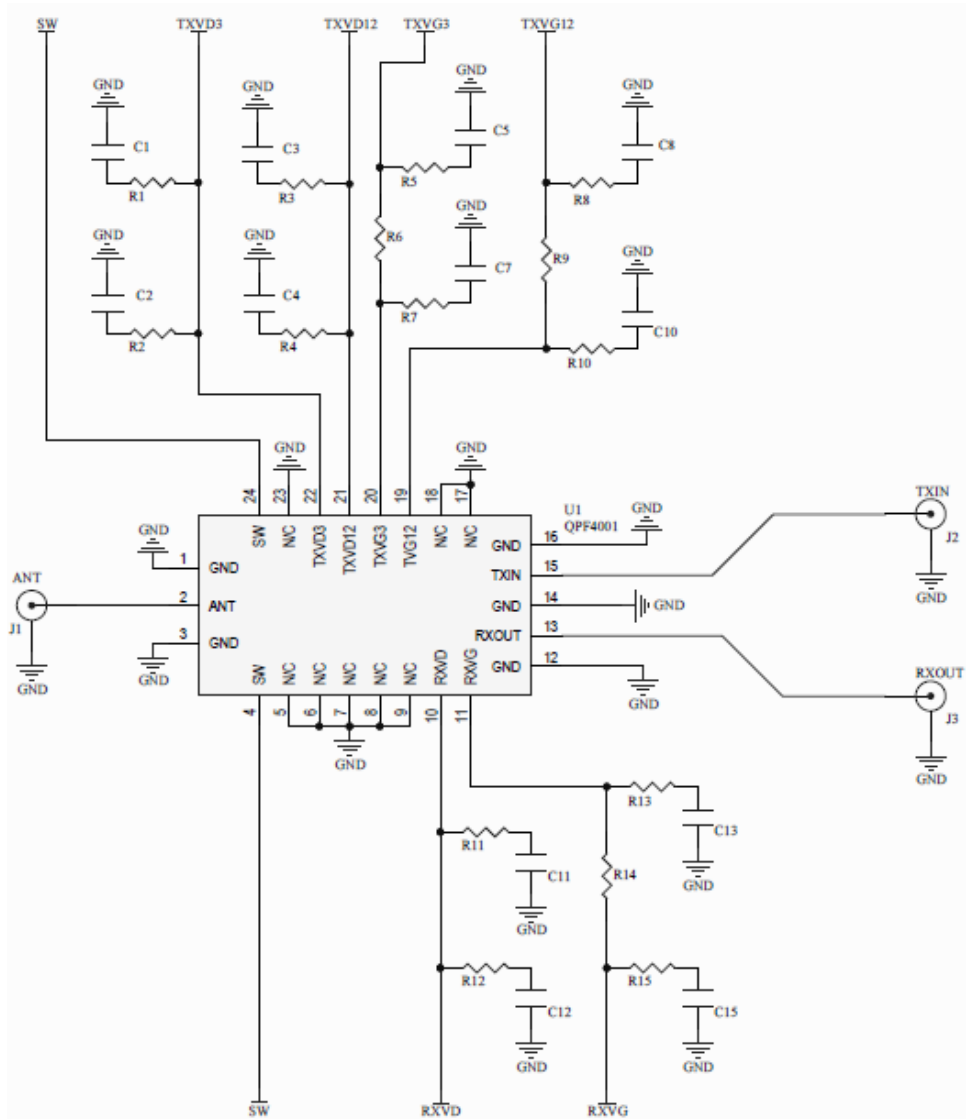

Bias-up Procedure

1. Set drain supply TXVD limit to 600 mA, RXVD limit to 50 mA, gate and control supply limit to 10 mA each.
2. Set TXVG12, TXVG3, RXVG to -5 V
3. Set SW = 0 V (or = RXVD) for TX (RX) operation (RXVD should be on during RX – and TX - operation)
4. Set TXVD12, TXVD3, RXVD = +20 V
5. For TX, adjust TXVG12 to get TXID12 current, adjust TXVG3 to achieve TXID3 current; For RX, adjust RXVG to achieve required drain current
6. Apply RF signal

Bias-down Procedure

1. Turn off RF signal
2. Set TXVG12, TXVG3 and RXVG to -5 V
3. Set all drain supply to 0 V
4. Turn off drain supply
5. Turn off SW
6. Turn off gate supply

Thermal Information

Parameter	Values	Units	Conditions
Average Power, Thermal Resistance (θ_{JC}) ⁽¹⁾	15.00	°C/W	TX on, RX off, TXVD = +20 V, TXIDQ = 88 mA CW RF Pout = 23 dBm, T _{BASE} = 85 °C P _{DISS} = 2.61 W, I _{D_DRIVE} = 0.14 A (total)
Channel Temperature (T _{CH})	124.16	°C	
Peak Power, Thermal Resistance (θ_{JC}) ⁽¹⁾	11.59	°C/W	TX on, RX off, TXVD = +20 V, TXIDQ = 88 mA CW RF Pout = 30 dBm, T _{BASE} = 85 °C P _{DISS} = 4.69 W, I _{D_DRIVE} = 0.28 A (total)
Channel Temperature (T _{CH})	139.36	°C	
Thermal Resistance (θ_{JC}) ⁽¹⁾	85.27	°C/W	RX on, TX off, RXVD = +20 V, RXIDQ = 15 mA RF off or small signal, T _{BASE} = 85 °C P _{DISS} = 0.3 W
Channel Temperature (T _{CH})	110.58	°C	

Notes:

1. Thermal resistance is measured to package backside
2. Base or ambient temperature is 85 C
3. Refer to the following document: [GaN Device Channel Temperature, Thermal Resistance, and Reliability Estimates](#)

Absolute Maximum Ratings

Parameter	Value
Drain Voltage (TXVD, RXVD)	28 V
Drain Current (TXID3+TXID12)	800 mA
Drain Current (RXID)	60 mA
Gate Voltage (RXVG, TXVG3, TXVG12)	0 to -5 V
Gate Control Current (RXIG, TXIG3, TXIG12)	20 mA
Switch Control Voltage (SW)	0 to 28 V
Switch Control Current	20 mA
RX Input Power (RF port, 85 °C)	25 dBm
TX Input Power (RF port, 85 °C)	20 dBm
Channel Temperature, T _{CH}	225 °C
Mounting Temperature (30 seconds)	260 °C
Storage Temperature	-55 to 150 °C

Operation of this device outside the parameter ranges given above may cause permanent damage. These are stress ratings only, and functional operation of the device at these conditions is not implied. Extended application of Absolute Maximum Rating conditions to the device may reduce device reliability.

Solderability

1. Compatible with the latest version of J-STD-020, Lead-free solder, 260 °C.
2. This package is non-hermetic, and therefore cannot be subjected to aqueous washing. The use of no-clean solder to avoid washing is highly recommended.

Recommended Soldering Temperature Profile

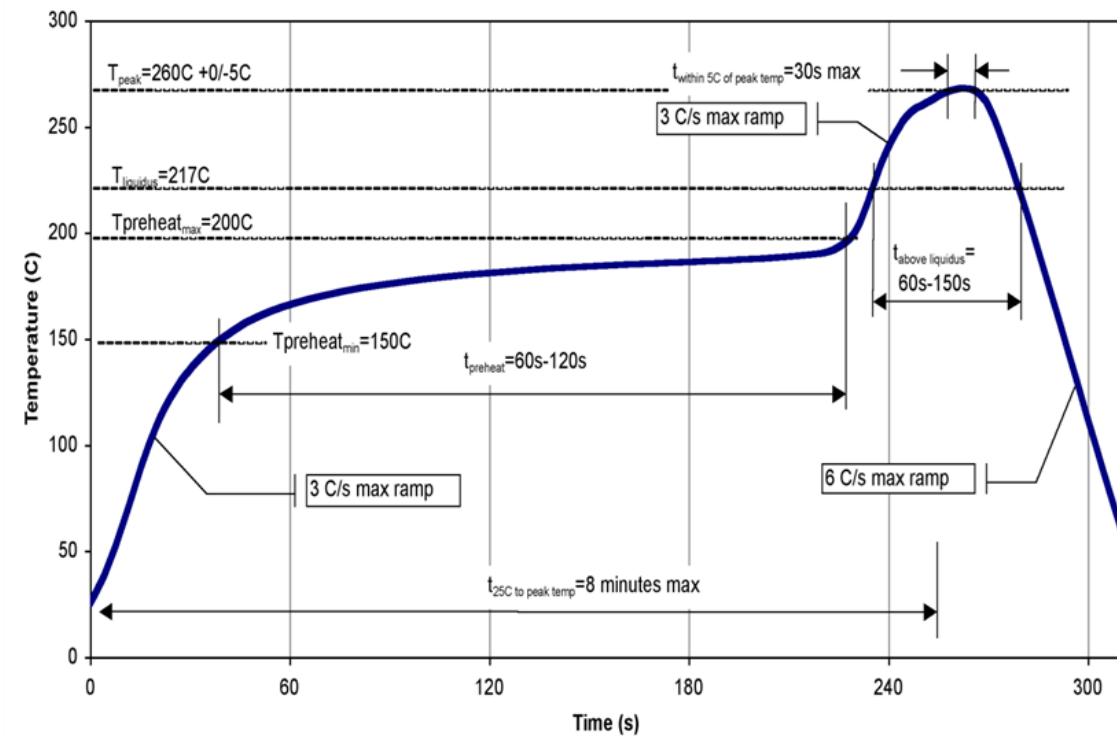

Handling Precautions

Parameter	Rating	Standard
ESD – Human Body Model (HBM)	0B	ESDA / JEDEC JS-001-2012
ESD – Charged Device Model (CDM)	C0b	ESDA / JEDEC JS-002-2014
MSL – Convection Reflow 260 °C	3	JEDEC standard IPC/JEDEC J-STD-020



Caution!
ESD-Sensitive Device

RoHS Compliance

This product is compliant with the 2011/65/EU RoHS directive (Restrictions on the Use of Certain Hazardous Substances in Electrical and Electronic Equipment), as amended by Directive 2015/863/EU. This product also has the following attributes:

- Lead Free
- Antimony Free
- TBBP-A (C₁₅H₁₂Br₄O₂) Free
- PFOS Free

Contact Information

For the latest specifications, additional product information, worldwide sales and distribution locations:

Tel: 1-844-890-8163

Web: www.qorvo.com

Email: customer.support@qorvo.com

Important Notice

The information contained herein is believed to be reliable; however, Qorvo makes no warranties regarding the information contained herein and assumes no responsibility or liability whatsoever for the use of the information contained herein. All information contained herein is subject to change without notice. Customers should obtain and verify the latest relevant information before placing orders for Qorvo products. The information contained herein or any use of such information does not grant, explicitly or implicitly, to any party any patent rights, licenses, or any other intellectual property rights, whether with regard to such information itself or anything described by such information. **THIS INFORMATION DOES NOT CONSTITUTE A WARRANTY WITH RESPECT TO THE PRODUCTS DESCRIBED HEREIN, AND QORVO HEREBY DISCLAIMS ANY AND ALL WARRANTIES WITH RESPECT TO SUCH PRODUCTS WHETHER EXPRESS OR IMPLIED BY LAW, COURSE OF DEALING, COURSE OF PERFORMANCE, USAGE OF TRADE OR OTHERWISE, INCLUDING THE IMPLIED WARRANTIES OF MERCHANTABILITY AND FITNESS FOR A PARTICULAR PURPOSE.**

Without limiting the generality of the foregoing, Qorvo products are not warranted or authorized for use as critical components in medical, life-saving, or life-sustaining applications, or other applications where a failure would reasonably be expected to cause severe personal injury or death.

Copyright 2020 © Qorvo, Inc. | Qorvo is a registered trademark of Qorvo, Inc.

Mouser Electronics

Authorized Distributor

Click to View Pricing, Inventory, Delivery & Lifecycle Information:

Qorvo:

[QPF4001EVB1](#) [QPF4001SR](#) [QPF4001TR7](#)